

Small size, High accuracy pressure control digital pressure sensor

■ Features

- High accuracy digital pressure sensor
- High brightness red LED(LED height : 9.5mm)
- High resolution : 1/1000
- Convertible pressure unit
 - Negative pressure, Compound pressure : kPa, kgf/cm², bar, psi, mmHg, mmH₂O, inHg
 - Standard pressure : kPa, kgf/cm², bar, psi
- Various output modes : Hysteresis mode, Automatic sensitivity setting mode, Independent 2 output mode, Window comparative output mode
- Chattering prevention for output (Selectable response time : 2.5, 5, 100, 500ms)
- Analog output(1-5VDC) scale function
- Reverse power polarity and overcurrent protection circuit
- Zero-point adjustment function
- Peak and Bottom hold display



⚠ Please read "Caution for your safety" in operation manual before using.



■ Ordering information

PS	A	-	V	01	C	P	-	Rc1/8	Pressure port	
									R1/8	Standard(PSA Series)
									NPT1/8	Option(PSA Series)
									M5	Standard(PSB Series)
									No mark	NPN open collector output
									P	PNP open collector output
									No mark	Positive(Cable integrated type)
									C	Connector type
									01	100kPa
									1	1,000kPa
									No mark	Standard pressure
									V	Negative pressure
									C	Compound pressure
									A	Regular square(30mm×30mm)
									B	Rectangular(10.2mm×54mm)
									PS	Pressure Sensor

Labels for the ordering code: Appearance (PS), Item (A), Cable (V), Pressure range (01), Pressure type (C), Output type (P), Pressure port (Rc1/8).

※1: It is only applied to PSB Series.

■ Pressure and Max. pressure display range

Type	kPa	kgf/cm ²	bar	psi	mmHg	inHg	mmH ₂ O
Negative pressure	0.0 to -101.3 (5.0 to -101.3)	0.000 to -1.034 (0.051 to -1.034)	0.000 to -1.013 (0.05 to -1.013)	0.00 to -14.70 (0.74 to -14.70)	0 to -760 (38 to -760)	0.0 to -29.9 (1.5 to -29.9)	0.0 to -103.4 (5.2 to -103.4)
Standard pressure	0.0 to 100.0 (-5.0 to 110.0)	0.000 to 1.020 (-0.051 to 1.122)	0.000 to 1.000 (-0.050 to 1.100)	0.00 to 14.50 (-0.72 to 15.96)	—	—	—
	0 to 1000 (-50 to 1100)	0.00 to 10.20 (-0.51 to 11.22)	0.00 to 10.00 (-0.50 to 11.00)	0.0 to 145.0 (-7.2 to 159.6)	—	—	—
Compound pressure	-100.0 to 100.0 (-101.2 to 110.0)	-1.020 to 1.020 (-1.034 to 1.122)	-1.000 to 1.000 (-1.012 to 1.100)	-14.50 to 14.50 (-14.70 to 15.96)	-750 to 750 (-760 to 824)	-29.5 to 29.5 (-29.8 to 32.6)	-102.0 to 102.0 (-103.4 to 112.2)

※() is Max. pressure display range.

※For using a unit mmH₂O, multiply display value by 100.

■ Pressure conversion chart

from	to	Pa	kPa	MPa	kgf/cm ²	mmHg	mmH ₂ O	psi	bar	inHg
1Pa	1	0.001	0.00001000	0.000010197	0.007501	0.101972	0.000145038	0.00010000	0.0002953	
1kPa	1000.000	1	0.001000	0.010197	7.500616	101.9716	0.145038	0.010000	0.2953	
1MPa	1000000	1000	1	10.197162	7500.61683	101971.553	145.038243	10	295.299875	
1kgf/cm ²	98066.54	98.066543	0.09806	1	735.5595	10000.20	14.22334	0.980665	28.95878	
1mmHg	133.322368	0.133322	0.000133	0.001359	1	13.5954	0.019336	0.001333	0.039370	
1mmH ₂ O	9.80665	0.00980	—	0.000099	0.0735578	1	0.00142	0.000098	0.002895	
1psi	6894.757	6.89757	0.00689	0.070307	51.71630	703.07	1	0.068947	2.036003	
1bar	100000.0	100.0000	0.100000	1.019689	750.062	10196.89	14.50339	1	29.52998	
1inHg	3386.417	3.388418	0.003386	0.034532	25.40022	345.31849	0.491158	0.033863	1	

Ex) For calculating 760mmHg as kPa : According to above chart, 1mmHg is 0.133322kPa, therefore 760mmHg will be 760×0.133322kPa=101.32472kPa.

- (A) Photo electric sensor
- (B) Fiber optic sensor
- (C) Door/Area sensor
- (D) Proximity sensor
- (E) Pressure sensor
- (F) Rotary encoder
- (G) Connector/Socket
- (H) Temp. controller
- (I) SSR/ Power controller
- (J) Counter
- (K) Timer
- (L) Panel meter
- (M) Tacho/ Speed/ Pulse meter
- (N) Display unit
- (O) Sensor controller
- (P) Switching mode power supply
- (Q) Stepper motor& Driver&Controller
- (R) Graphic/ Logic panel
- (S) Field network device
- (T) Software
- (U) Other

PSA / PSB Series

■ Specifications

Pressure type		Gauge pressure			
		Negative pressure	Standard pressure		Compound pressure
Model ※1	NPN open collector output	PSA-V01-□ PSB-V01-□ PSB-V01C-□	PSA-01-□ PSB-01-□ PSB-01C-□	PSA-1-□ PSB-1-□ PSB-1C-□	PSA-C01-□ PSB-C01-□ PSB-C01C-□
	PNP open collector output	PSA-V01P-□ PSB-V01P-□ PSB-V01CP-□	PSA-01P-□ PSB-01P-□ PSB-01CP-□	PSA-1P-□ PSB-1P-□ PSB-1CP-□	PSA-C01P-□ PSB-C01P-□ PSB-C01CP-□
Rated pressure range		0.0 to -101.3kPa	0.0 to 100.0kPa	0.0 to 1,000kPa	-100.0 to 100.0kPa
Display and set pressure range		5.0 to -101.3kPa	-5.0 to 110.0kPa	-50 to 1,100kPa	-101.2 to 110.0kPa
Max. pressure range		2 times of rated pressure		1.5 times of rated pressure	2 times of rated pressure
Applied fluid		Air, Non-corrosive gas			
Power supply		12-24VDC ±10%(Ripple P-P : Max. 10%)			
Current consumption		Max. 50mA			
Control output		NPN or PNP open collector output • Load voltage: Max. 30VDC • Load current: Max. 100mA • Residual voltage - NPN: Max. 1V, PNP: Max. 2V			
Hysteresis※2		1digit fixed(2digits for psi unit)			2digit fixed
Repeat error		±0.2% F.S. ±1digit			±0.2% F.S. ±2digit
Response time		Selectable 2.5ms, 5ms, 100ms, 500ms			
Short circuit protection		Built-in			
Analog output		• Output voltage: 1-5VDC ±2% F.S. • Zero-point: Within 1VDC ±2% F.S. • Span: Within 4VDC ±2% F.S. • Linear: Within ±2% F.S. • Resolution: Approx. 1/200 • Output impedance: 1kΩ			
Display digit		3½digit			
Display method		7Segment LED			
Min. display interval		1digit(psi unit: 2 digits are fixed)			2digits
Pressure unit		kPa, kgf/cm ² , bar, psi, mmHg, mmH ₂ O, inHg	kPa, kgf/cm ² , bar, psi		kPa, kgf/cm ² , bar, psi, mmHg, mmH ₂ O, inHg
Display accuracy		0°C to 50°C: Max. ±1% F.S., -10 to 0°C : Max. ±2% F.S.			
Environment	Ambient temperature	-10 to 50°C, storage: -20 to 60°C			
	Ambient humidity	35 to 95%RH, storage: 35 to 95%RH			
Vibration		1.5mm amplitude at frequency of 10 to 55Hz(for 1 min.) in each of X, Y, Z directions for 2 hours			
Material		• PSA: Front case: PC, Rear case: PC(Insert glass), Pressure port: die-cast(Zn) • PSB: Case, Pressure port: PA • PSB-C: Case, Pressure port, Cover: IXEF			
Protection		IP40(IEC standard)			
Cable	Cable integrated type	ø4, 5-wire, Length : 2m (AWG24, Core diameter: 0.08mm, Number of cores: 40, Insulation out diameter: ø1mm)			
	Connector type	5-wire, Length : 3m(AWG24, Insulation out diameter : ø1mm)			
Approval		CE			
Unit weight		• PSA: Approx. 120g • PSB: Approx. 70g • PSB-C: Approx. 80g			

※1: '□' is pressure port type.

※2: In hysteresis output mode, detection difference is variable.

※ There may be ±1digit error in hysteresis by pressure unit calculation error.

※ The specification of pressure port is marked on the upper part of the case.

Pressure ports are distinguished by the colors, silver [Rc(PT)1/8] or black [NPT1/8].

※ Environment resistance is rated at no freezing or condensation.

※ F.S.: Rated pressure.

● Analog output voltage-Pressure characteristic

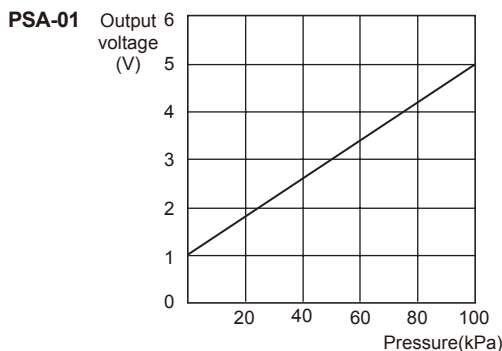

● Analog output voltage-Linear characteristic

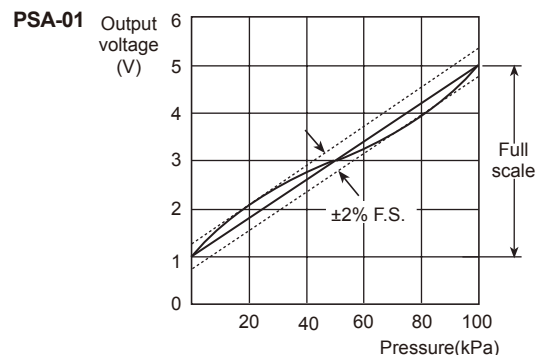

Pressure Sensor

■ Dimensions

(unit: mm)

● PSA Series

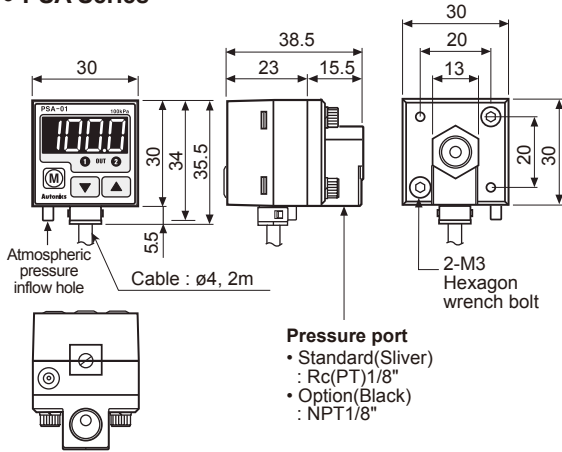

● PSB Series

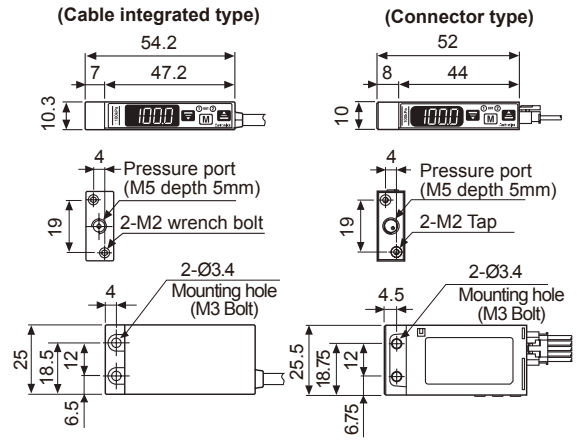

● Fixing bracket A for mounting(PSA Series)

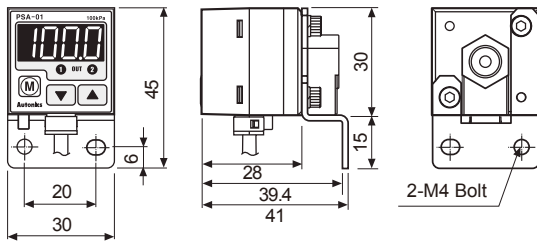

● Fixing bracket B for mounting(PSA Series)

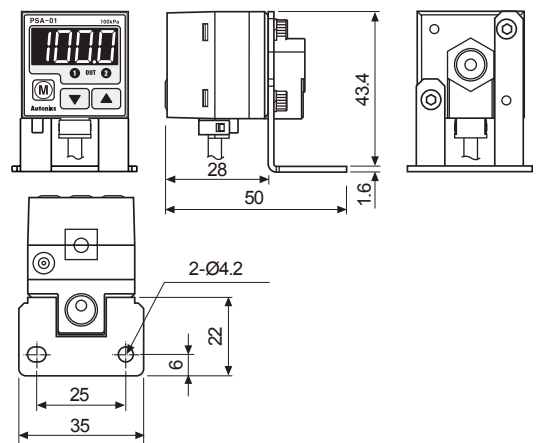

● Panel mounting bracket(PSA Series)

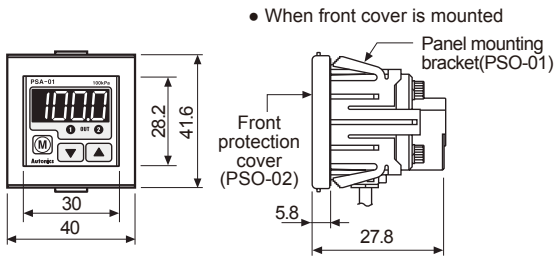

● Bracket A

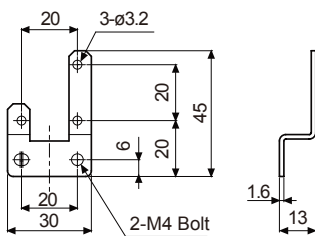

● Bracket B

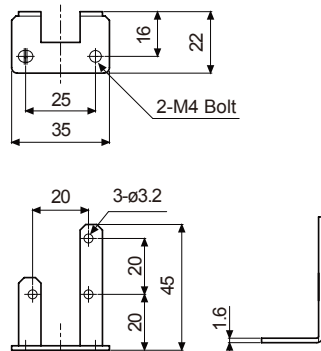

● Panel cut-out

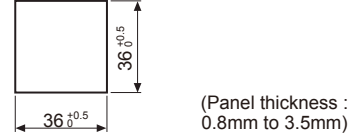

● Accessory(sold separately)

● Panel mounting bracket (PSO-01)



● Front protection cover (PSO-02)

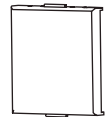

(A) Photo electric sensor

(B) Fiber optic sensor

(C) Door/Area sensor

(D) Proximity sensor

(E) Pressure sensor

(F) Rotary encoder

(G) Connector/Socket

(H) Temp. controller

(I) SSR/ Power controller

(J) Counter

(K) Timer

(L) Panel meter

(M) Tacho/ Speed/ Pulse meter

(N) Display unit

(O) Sensor controller

(P) Switching mode power supply

(Q) Stepper motor& Driver&Controller

(R) Graphic/ Logic panel

(S) Field network device

(T) Software

(U) Other

PSA / PSB Series

Control output diagram(PSA/PSB)

NPN open collector output type

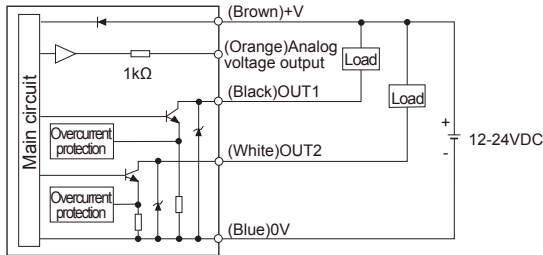

PNP open collector output type

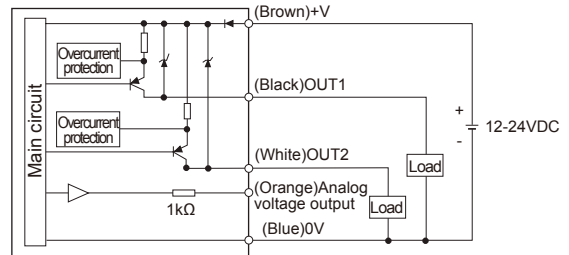

※There is no short-circuit protection in analog voltage output. Do not connect this output to power supply or capacitive load directly.
 ※Please observe input impedance of connected equipment when use analog voltage output.
 And be sure to check voltage drop caused by resistance of extended wire.

Front panel identification

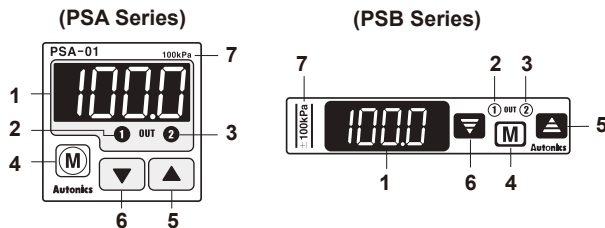

1. 3½digit LED display(red)

: Display sensing pressure, every setting value and display error.

2. 1 output indicator(red) : Output 1 is ON, LED will be ON.

3. 2 output indicator(PSA: red, PSB: green)

: Output 2 is ON,LED will be ON.

4. Mode key

: Parameter setting mode or preset setting mode, save setting value.

5. Up key

: Set the setting value to lower step in preset setting or pressure unit, output mode, response time, analog output scale, key lock, peak hold value, bottom hold value display in parameter setting.

6. Down key

: Set setting value to upper step in preset setting or pressure unit, output mode, response time, analog output scale, key lock, peak hold, bottom hold display in parameter setting.

7. Range of rated pressure

: It is possible to change the pressure unit in PSA Series. Please use different unit as label for your application.

Setting(PSA/PSB)

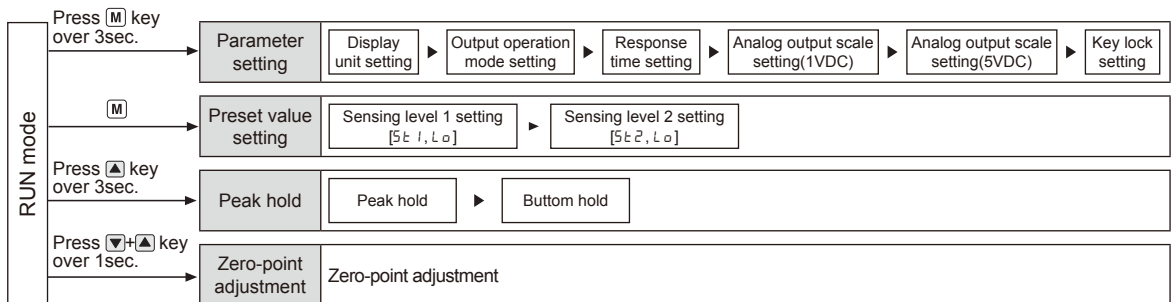

Zero point adjustment(PSA/PSB)

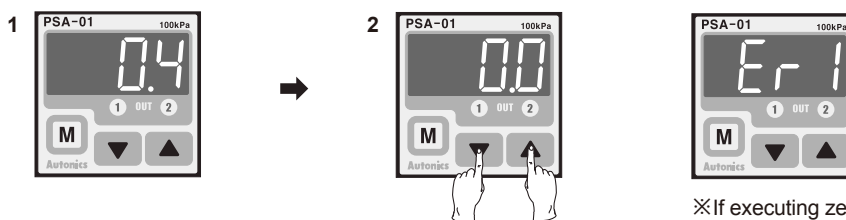

1. In state of atmospheric pressure during RUN mode, press ∇ key and \blacktriangle key at the same time for over 1sec.

2. When the zero point adjustment is completed, it will display 0.0 and return to RUN mode automatically.

※Please execute zero point adjustment regularly.

※If executing zero point adjustment when external pressure has been applied, Er 1 will be flashing. Please execute zero point again in state of atmospheric pressure.

Parameter setting(PSA/PSB)

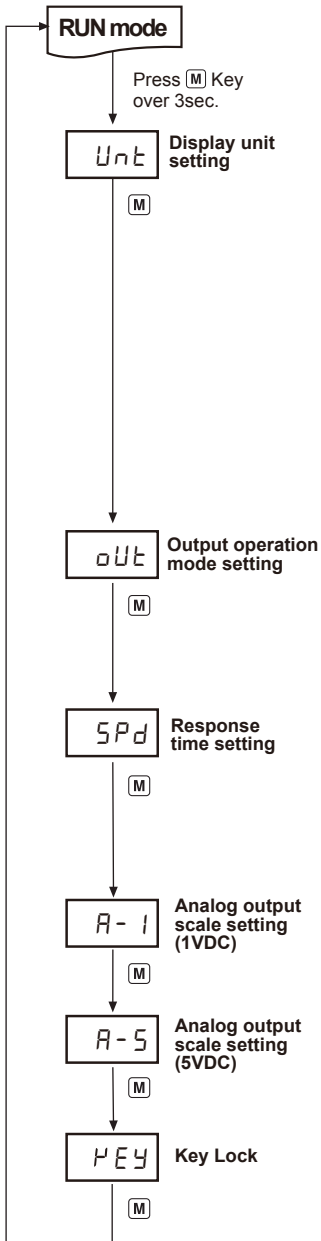

Unit and previously set unit will flash in turn every 0.5 sec.
Press \downarrow or \uparrow key to select the unit.

(Press [M] key momentarily, the unit will be saved, then move to the next mode.)

• Negative pressure, compound pressure:

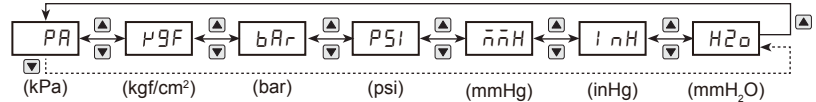

• Standard pressure:

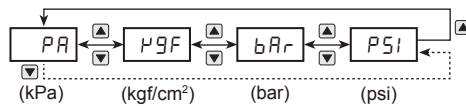

※For using mmH₂O unit, multiply display value by 100.

Out and previous output operation mode will flash by turning on.(0.5sec.)

Select the output operation mode with \downarrow , \uparrow Key.

(Press [M] key momentarily, the response time will be saved, then move to the next mode.)

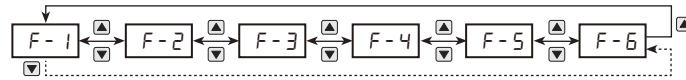

Spd and the previous response time will flash by turning on.(0.5sec.)

Select the output operation mode with \downarrow , \uparrow Key.

(Press [M] key momentarily, the response time will be saved, then move to the next mode.)

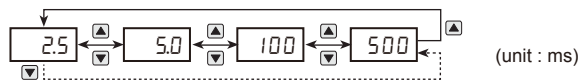

A-1 and the previous pressure will flash by turning on.(0.5sec.)

Set the pressure which will output 1VDC with \downarrow , \uparrow Key.

□Allowable setting range : Min. value of rated pressure $\leq [A-1] \leq 90\%$ of rated pressure

(Press [M] key momentarily, the selected pressure is set as 1VDC scales, then move to the next mode.)

A-5 and the previous pressure will flash by turning on.(0.5sec.)

Set the pressure which will output 5VDC by \downarrow , \uparrow Key.

□Allowable setting range : $[A-1] + 10\%$ of rated pressure $\leq [A-5] < \text{Max. value of rated pressure}$

(Press [M] key momentarily, the selected pressure is set as 5VDC scales, then move to the next mode.)

Key and the previous key lock will flash by turning on(0.5sec.)

Select key lock with \downarrow , \uparrow Key.

(Press [M] key momentarily, key lock is set, then move to the display unit setting mode.)

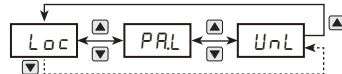

※Key lock functions

- Loc : Disable to change preset value and parameter value (Enable to change Key mode only)
- PRL : Enable to change preset value, disable to change parameter value
- UnL : Enable to change preset value and parameter value(Lock off)

※When advance to parameter setting mode and preset setting mode, it displays "Setting item" and "Previous setting value" by 0.5 sec. turn. This display will stop by pressing \downarrow or \uparrow key(Display setting value), if any key is untouched for over 1 sec., it will display old value by 0.5sec. turn again.

※When [M] key is pressed for 3sec. during setting, it will return to RUN mode with memorizing on EEPROM. However, when there is any key is untouched for 60sec., it turns to RUN mode with keeping the previous setting value not current setting value.

※There is memory protection by EEPROM, but life cycle of EEPROM is 100,000 times.

(A)	Photo electric sensor
(B)	Fiber optic sensor
(C)	Door/Area sensor
(D)	Proximity sensor
(E)	Pressure sensor
(F)	Rotary encoder
(G)	Connector/Socket
(H)	Temp. controller
(I)	SSR/Power controller
(J)	Counter
(K)	Timer
(L)	Panel meter
(M)	Tacho/Speed/Pulse meter
(N)	Display unit
(O)	Sensor controller
(P)	Switching mode power supply
(Q)	Stepper motor& Driver&Controller
(R)	Graphic/Logic panel
(S)	Field network device
(T)	Software
(U)	Other

PSA / PSB Series

■ Preset value setting(PSA/PSB)

◎ Hysteresis mode[F - 1] and independent 2 output mode[F - 3, F - 4, F - 5]

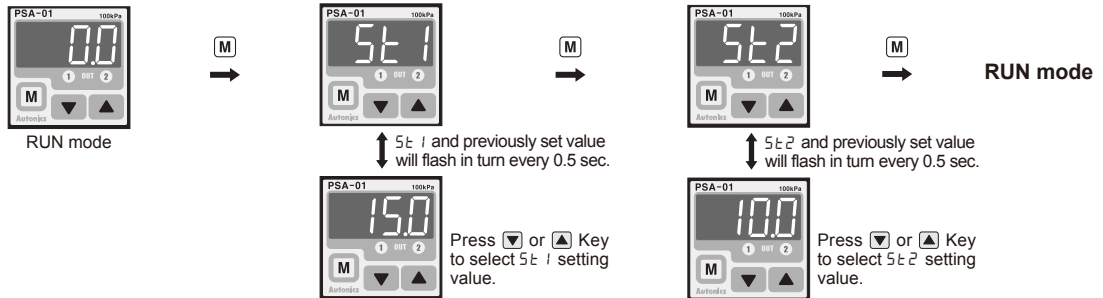

※5t1 setting range : Min. display pressure < 5t1 ≤ Max. display pressure

※5t2 setting range : - Hysteresis mode: Min. display pressure ≤ 5t2 < 5t1

- 2 independent output mode: Min. display pressure < 5t2 ≤ Max. display pressure

◎ Automatic sensitivity setting mode[F - 2]

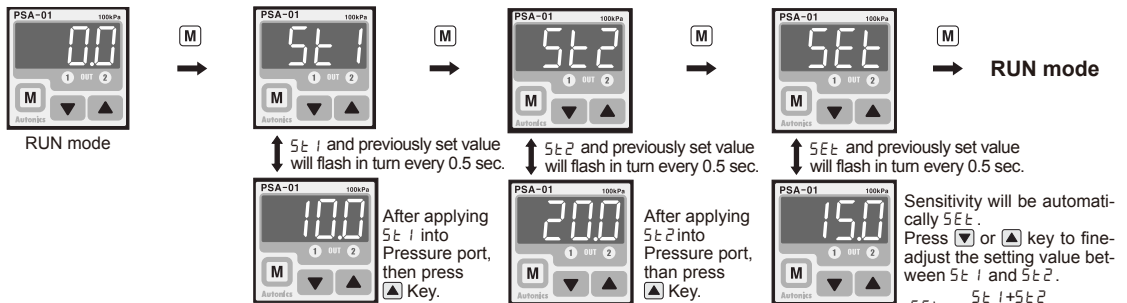

※5t1 setting range : Min. display pressure < 5t1 ≤ Max. display pressure – 1% of rated pressure

※5t2 setting range : 5t1 + 1% of rated pressure < 5t2 ≤ Max. display pressure

Adjustable range of set value: Between 5t1 and 5t2.

$$5Et = \frac{5t1 + 5t2}{2}$$

◎ Window comparison output mode[F - 5]

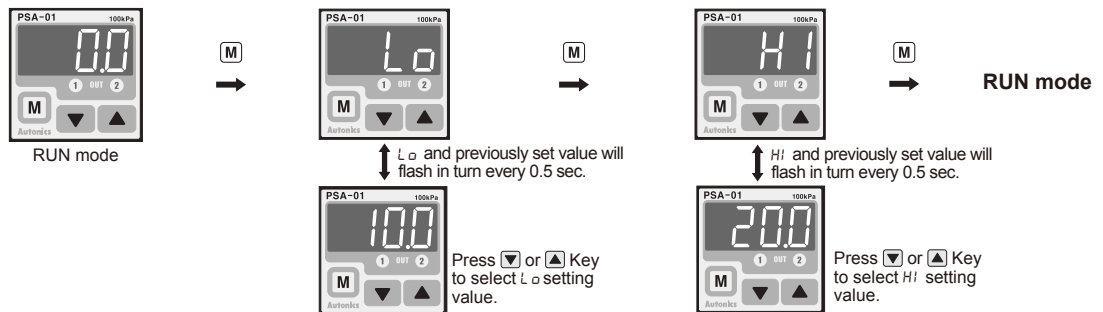

※Low value setting range : Min. display pressure < Lo ≤ Max. display pressure

※High value setting range : Lo < Hi ≤ Max. display pressure

- If no key is touched for 60sec., it will return to RUN mode. [Automatic sensitivity setting mode[F - 2] is exception]
- When changing the display unit, preset value will be calculated according to the display unit.
- Whenever key touched one time, it is increased(decreased) as 1 digit(2 digits for psi unit and compound pressure) but it will be continuously increasing(decreasing) by pressing **▼**, **▲** key constantly.

■ Peak hold and bottom hold check

1. Press **▲** key for over 3sec. in RUN mode.
 2. **PEH** and memorized max. pressure(Negative pressure type is for max. negative pressure) will flash by turning on (0.5sec.) then display peak hold value.
 3. **boH** and memorized min. pressure(Negative pressure type is for min. negative pressure) will flash by turning on (0.5sec.) then display bottom hold value.
 4. If pressing **▲** key one time shortly, memorized peak hold and bottom hold value will be removed then return to RUN mode.
- ※When the peak hold and bottom hold value is over the max. display pressure value, it displays **HHH**, On the opposite, it displays **LLL**. Please remove peak hold and bottom hold value by using **▲** key.

■ Output operation mode(PSA/PSB)

1. Hysteresis mode [F - 1]

※It can be set for pressure sensing level[$5E1$] and sensing difference[$5E2$].

※ $5E1$ setting range

: Min. display pressure < $5E1$ ≤ Max. display pressure

$5E2$ setting range

: Min. display pressure ≤ $5E2$ < $5E1$

- OUT 1: When applying pressure is larger than $5E1$, it will be ON.
- OUT 2: When applying pressure is lower than $5E2$, it will be ON.

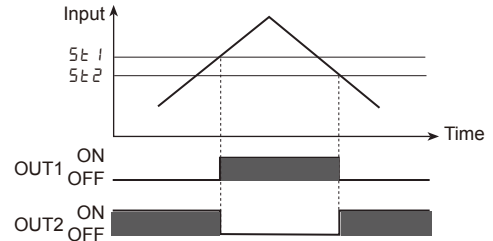

2. Automatic sensitivity setting mode [F - 2]

※This function is to set pressure sensing level to the proper position automatically, it is set by received pressure from two positions [$5E1$, $5E2$].

※The sensing hysteresis fixed to 1 digit(2 digits for psi unit and compound type)

※The pressure sensing level [$5E1$] is shown in the following calculation.

$$5E1 = \frac{(5E1 + 5E2)}{2}$$

- OUT 1: When applying pressure is larger than $5E1$ value, it will be ON.
- OUT 2: When applying pressure is between $5E1$ and $5E2$, it will be ON.

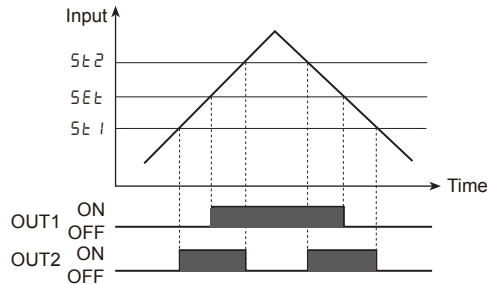

Note1) If it is not enough for difference of sensing level between $5E1$ and $5E2$, $E-3$ will be displayed. Please set again after applying enough pressure.

Note2) $5E1$ setting range: Min. display pressure < $5E1$ ≤ Max. display pressure -1% of rated pressure
 $5E2$ setting range: $5E1$ +1% of rated pressure ≤ $5E2$ ≤ Max. display pressure

Note3) If fine adjustment for sensing level is required, adjust sensing level by ∇ , \blacktriangle key.
 (Adjustment range : Between $5E1$ and $5E2$)

3. Independent 2 output mode [F - 3, F - 4, F - 5]

※ $5E1$ and $5E2$ can be set independently within display pressure range. One is for control, the other is for alarm or optional control.

※The sensing hysteresis fixed to 1 digit(2 digits for psi unit and compound type)

※ $5E1$ setting range

: Min. display pressure ≤ $5E1$ ≤ Max. display pressure

$5E2$ setting range

: Min. display pressure ≤ $5E2$ ≤ Max. display pressure

• Independent 2 output mode [F - 3]

• OUT 1: It will be ON, when it is over $5E1$.

• OUT 2: It will be ON, when it is over $5E2$.

• Independent 2 opposite mode [F - 4]

• OUT 1: It will be OFF when it is over $5E1$.

• OUT 2: It will be OFF, when it is over $5E2$.

• Independent 2 cross mode [F - 5]

• OUT 1: It will be OFF when it is under $5E1$.

• OUT 2: It will be ON, when it is under $5E2$.

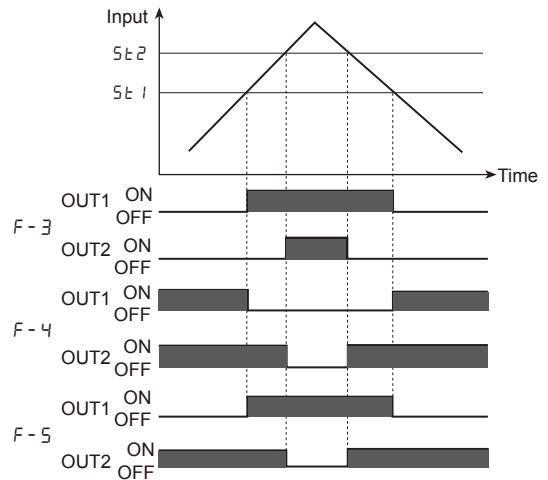

4. Window comparison output mode [F - 6]

※It is able to set High limit value [Hl], Low limit value [Lo] of pressure sensing level in this mode.

※The sensing hysteresis fixed to 1 digit(psi unit and compound type 2 digits)

※ Lo setting range

: Min. display pressure ≤ Lo ≤ Max. display pressure

Hl setting range : Lo < Hl ≤ Max. display pressure

- OUT 1: It will be ON between high limit value[Hl] and low limit value[Lo]
- OUT 2: It will be ON when it is over high limit value[Hl] and low limit value[Lo].

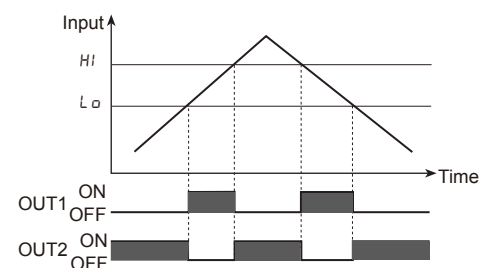

(A) Photo electric sensor

(B) Fiber optic sensor

(C) Door/Area sensor

(D) Proximity sensor

(E) Pressure sensor

(F) Rotary encoder

(G) Connector/Socket

(H) Temp. controller

(I) SSR/Power controller

(J) Counter

(K) Timer

(L) Panel meter

(M) Tacho/Speed/Pulse meter

(N) Display unit

(O) Sensor controller

(P) Switching mode power supply

(Q) Stepper motor& Driver&Controller

(R) Graphic/Logic panel

(S) Field network device

(T) Software

(U) Other

PSA / PSB Series

■ Functions(PSA/PSB)

◎ Pressure unit change

PS□-V01(C)(P)/PS□-C01(C)(P) has 7 kinds of pressure unit and PS□-01(C)(P)/PS□-1(C)(P) has 4 kinds of pressure unit.

Please select the proper unit for application.

- PS□-V01(C)(P), PS□-C01(C)(P) : kPa, kgf/cm², bar, psi, mmHg, inHg, mmH₂O
 - PS□-01(C)(P), PS□-1(C)(P) : kPa, kgf/cm², bar, psi
- ※When using mmH₂O multiply the display value by 100.

◎ Output mode change

There are 6 kinds of control output modes in order to provide the various detection. Select a mode for your proper application.

• Hysteresis mode [F- 1]

When variable hysteresis is required for pressure detection.

• Automatic sensitivity setting mode [F- 2]

When it is required to set detecting sensitivity automatically at proper position.

• Independent 2 output mode [F- 3, F- 4, F- 5]

When it is required to detect pressure from two position with one product.

• Window comparison output mode [F- 5]

When is required to detect pressure in a certain range.

◎ Response time change (chattering prevention)

It can prevent chattering of control output by changing response time. It is able to set 4 kinds of response time(2.5, 5, 100, 500ms) and if the response is getting longer, the sensing will be more stable by increasing the number of digital filter.

◎ Analog output scale setting

It is not fixed the analog output(1-5VDC) scale as the rated pressure range but this is a function to change properly for user's application. When the position[R- 1] for 1VDC output and the position [R- 5] for 5VDC output are set, the pressure range of R- 1 to R- 5 is to 1-5VDC analog output.

◎ Key lock

This unit has 2 kinds of key lock function in order to prevent wrong operation.

- **L o C** : All keys are locked, it is impossible to change any parameter setting/preset, zero point adjustment, peak hold and bottom hold. (Enable to change μ E Y mode only).
- **P R L** : This is partial locked status, it is impossible to change parameter setting. (Enable to change μ E Y mode only).
- **U n L** : All keys are unlocked.

◎ Zero-point adjustment

This function is to set the display value of pressure at zero when port is opened to atmospheric pressure.

◎ Peak hold and bottom hold

This function is diagnosis malfunction of the system caused by parasitic pressure or to check through memorizing the max./min. pressure that occurred in the system.

◎ Error display

Error display	Description	Troubleshooting
E r 1	When external pressure is input while adjusting zero point	Try again after removing external pressure
E r 2	When overload is applied on control output	Remove overload
E r 3	When the setting value is not matched with setting condition	Check setting conditions and set proper setting values
H H H	When applied pressure exceeds High-limit of display pressure range	Apply pressure within display pressure range
L L L	When applied pressure exceeds Low-limit of display pressure range	

■ Installation (PSA Series)

1. When installing pressure port, it is able to bring pressure from 3 directions by changing the mounting direction of the pressure port.
2. Basic spec of pressure port is Rc(PT) 1/8"(color: Silver). [option:NPT 1/8(color: black)] It is able to use general one touch fitting.

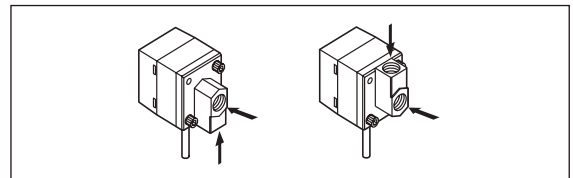

3. Please use seal tape at port plug in order to prevent pressure leak.
4. Please block another two pressure ports not used with port plug.

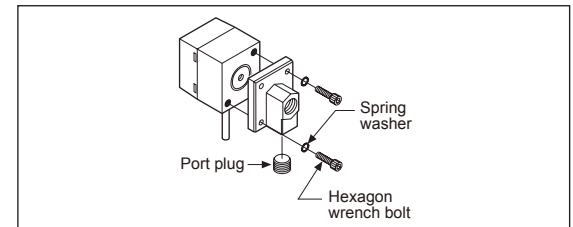

5. Please connect it by using spanner(13mm) at the metal part in order not to overload on the body when connecting one touch fitting.

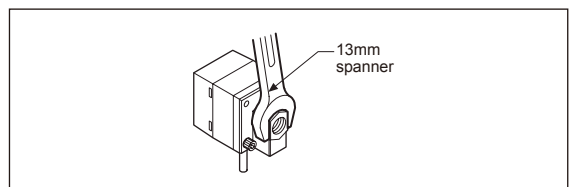

⚠ Caution

The tightening torque of one touch fitting should be max.100kgf-cm. If not, it may cause mechanical problem.

Pressure Sensor

- PSA Series has 2 kinds of brackets so it is able to install it in two different ways.
- At first, please unscrew hexagon wrench bolt and assemble the bracket on this unit by fixing the hexagon wrench bolt.

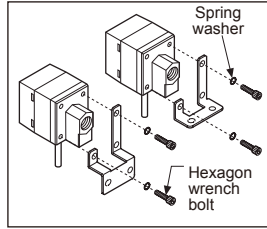

⚠ Caution

In this case, tightening torque of hexagon wrench should be max. 30kgf-cm. If not, it may cause mechanical problem.

- Bracket(PSO-01) and front protection cover(PSO-02) are sold separately. Please see the pictures for installation.

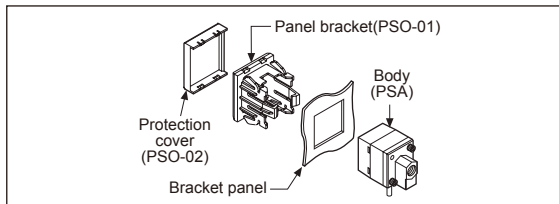

■ Installation(PSB Series)

- Pressure port is M5. Use general one touch fitting.

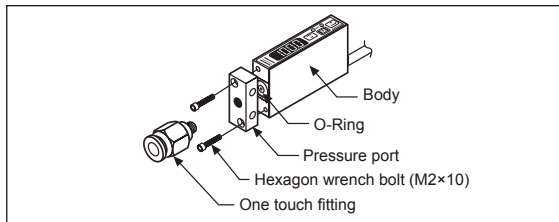

- It is able to use it without the pressure port according to environment. In this case O-Ring between pressure port and its body should not be taken out in order to prevent pressure leak.

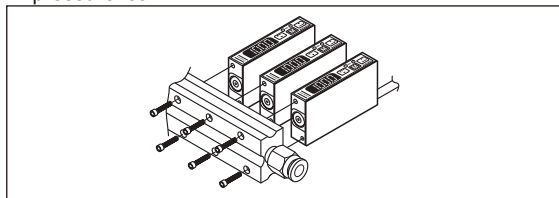

- Please connect it by using spanner(10mm) at pressure port in order not to overload on the body when connecting one touch fitting.

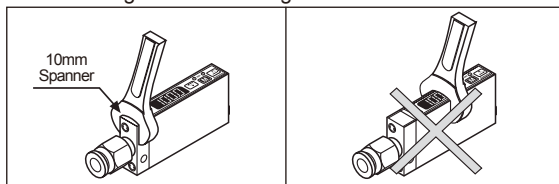

⚠ Caution

The tightening torque of one touch fitting and hexagon wrench should be Max. 50kgf-cm and 20kgf-cm. It may cause mechanical trouble. Please do not use spanner to install as it may cause mechanical trouble.

■ Proper usage

⚠ Caution

PSA, PSB Series is for sensing of non corrosive gas. Do not use this product at corrosive gas or flammable gas, etc.

- Please using this unit within the range of specification, if applying pressure is larger than specification, it may not be working properly due to damage.
- After supplying power, it takes 3 sec. to work.
- When using switching mode power supply, frame ground (F.G.) terminal of power supply should be grounded.

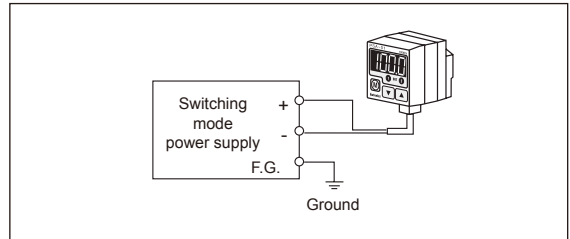

- It may cause malfunction by noise, when wiring with power line or high voltage line.
- Do not insert any sharp or pointed object into pressure port. It may cause mechanical problem due to sensor damage.
- Do not use this unit with flammable gas, because this is not an explosion proof structure.
- Be sure that this unit should not be contacted directly with water, oil, thinner, etc.

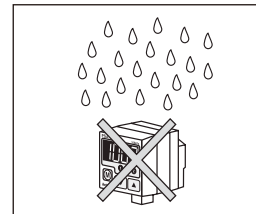

- Wiring must be done with power off.

■ Accessory

● PSA/PSB

- Pressure unit label

±100kPa	±101.3kPa	100kPa	1MPa
±1.020mg/gftr	-1.034mg/gftr	1.020mg/gftr	10.220mg/gftr
±14.50psi	-14.70psi	14.50psi	145.0psi
±1.000bar	-1.013bar	1.000bar	10.000bar
±750mmHg	-760mmHg	×10	×10
±29.5mmHg	-29.9mmHg	×100	×100
±102.0mmH ₂ O	-103.4mmH ₂ O	×1000	×1000

DISPLAY UNIT LABEL

● Only for PSA Series

- Port plug
- Bracket A
- Bracket B

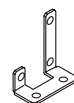
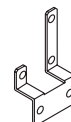

(A) Photo electric sensor

(B) Fiber optic sensor

(C) Door/Area sensor

(D) Proximity sensor

(E) Pressure sensor

(F) Rotary encoder

(G) Connector/Socket

(H) Temp. controller

(I) SSR/Power controller

(J) Counter

(K) Timer

(L) Panel meter

(M) Tacho/Speed/ Pulse meter

(N) Display unit

(O) Sensor controller

(P) Switching mode power supply

(Q) Stepper motor& Driver&Controller

(R) Graphic/Logic panel

(S) Field network device

(T) Software

(U) Other